

# Philippe Starck Two-Handle Lavatory Mixer 10030XX1

Available in chrome (00) and satinox (81)

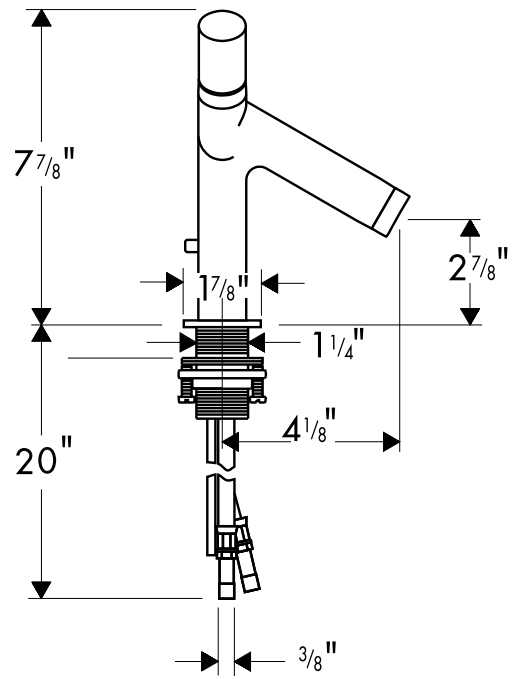
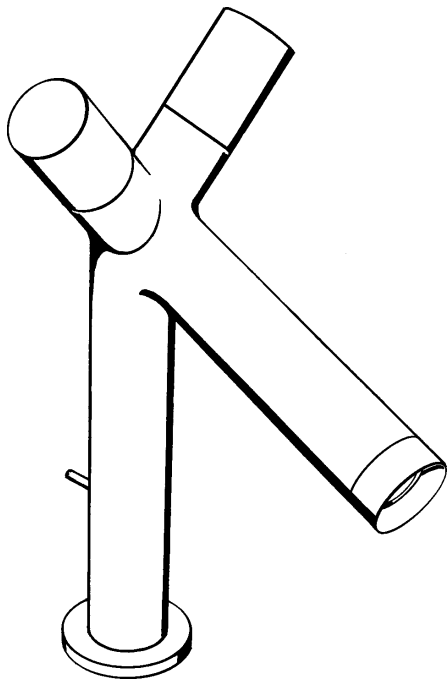

## Product Specification

Hole size in mounting surface	Minimum 1-1/4"	Maximum 1-5/8"
Maximum mounting surface depth	1-1/4"	
Flow rate	2.2 GPM	
Maximum incoming water pressure	145 PSI	
Recommended incoming water pressure	22 - 72.5 PSI	
Recommended incoming hot water temp	120° - 140° F*	
Ceramic valve cartridges		

\*Some governing bodies require that the water heater be set to 120°F or less. Please know and follow all local codes when setting the temperature on the water heater.

**AXOR**<sup>®</sup>